



 LED VEKSAN

BLOW



VEKSAN, bu ürün hakkında önceden haber vermeksizin deęişiklik yapma ve bu deęişiklięi derhal uygulama hakkını saklı tutar. /

VEKSAN keeps it's right to make changes and apply immediately without declaring in advance.

LED

A++

A+

A

B

C

D

E

## BLOW

Çekici,  
Attractive

Oval,  
Oval

Etkili...  
Effective

Farklı tavan tiplerine uygun ve özel oval geometrik lens yapısıyla BLOW, aynı anda iki farklı ışık kaynağı ile mekanlarına değer katmak isteyenlere benzersiz ve çekici bir etki sunar.

With it's special oval shaped diffuser , different ceiling adaptable BLOW offers an attractive and unique effect by two different light sources to those who wants to add value to their places.



# BLOW AR

Sıva Altı Armatürler / Recessed Luminaires



Polyester elektrostatik toz boyalı gövde /  
Electrostatic polyester powder coated

Yüksek geçirgenlikli satine PMMA veya PC opal difüzör /  
High diffusion and transmission satin opal PMMA or PC diffuser

G53 AR111 LED spot seçeneği /  
G53 AR111 LED spotlight option

Estetik aydınlatma / Aesthetics illumination

MacAdam 3 LED renk toleransı /  
Colour tolerance MacAdam 3

DALI, SwitchDIM ve Acil seçenekleri /  
DALI, SwitchDIM and Emergency options

## Özellikler / Specifications



## Renk Seçenekleri / Colour Options



Beyaz  
White

## Fotometrik Bilgi / Photometric Data

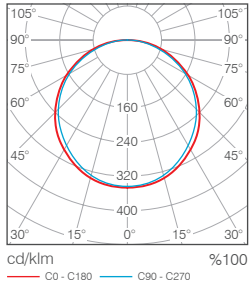

## Tavan Bilgi / Ceiling Data

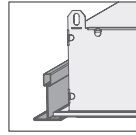

T15 veya T25 tavanlar /  
T15 or T25 exposed T

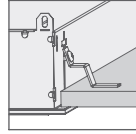

Alçı tavanlar /  
Plaster board ceilings

## Teknik Çizim / Technical Drawing

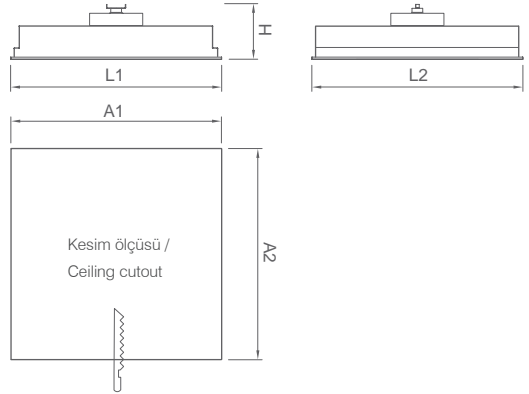

## Teknik Bilgi / Technical Data

Güç (W)	Çıkış / Output (lm)	Verimlilik (lm/W)	CRI (Ra)	Renk Sıcaklığı (K)	Ölçüler / Dimensions (mm)	Ağırlık (kg)	Ürün Kodu (Item Code)
42W + 15W	2600+850	62	>80	3000	A1: 575, A2: 575, L1: 595, L2: 595, H: 95	7,4	171 0 660 3 242
42W + 15W	2720+900	64	>80	4000	A1: 575, A2: 575, L1: 595, L2: 595, H: 95	7,4	171 0 660 4 242
54W + 15W	3200+850	59	>80	3000	A1: 575, A2: 575, L1: 595, L2: 595, H: 95	7,4	171 0 660 3 131
54W + 15W	3360+900	62	>80	4000	A1: 575, A2: 575, L1: 595, L2: 595, H: 95	7,4	171 0 660 4 131

## Ek Kod / Suffix Code

- (300) 3 saat Acil çıkış kiti / 3 hours Emergency gear
- (010) DALI

\* Tavan tipini belirtiniz. / Please indicate type of ceiling.

\*\* L demiri askı takımı, alçı tavanlar için / L brackets for plaster board ceilings

\*\*\* Lütfen daha fazla bilgi için satış temsilcileri ile görüşün. / Please contact for more information.

# BLOW

Sıva Altı Armatürler / Recessed Luminaires



Polyester elektrostatik toz boyalı gövde /  
Electrostatic polyester powder coated

Yüksek geçirgenlikli satine PMMA veya PC opal difüzör /  
High diffusion and transmission satin opal PMMA or PC diffuser

Estetik aydınlatma / Aesthetics illumination

MacAdam 3 LED renk toleransı /  
Colour tolerance MacAdam 3

DALI, SwitchDIM ve Acil seçenekleri /  
DALI, SwitchDIM and Emergency options

## Özellikler / Specifications



## Renk Seçenekleri / Colour Options



## Fotometrik Bilgi / Photometric Data

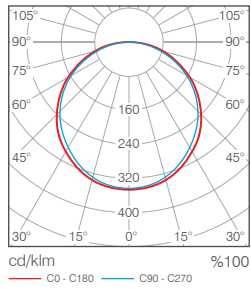

## Tavan Bilgi / Ceiling Data

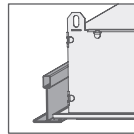

T15 veya T25 tavanlar /  
T15 or T25 exposed T

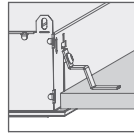

Alçı tavanlar /  
Plaster board ceilings

## Teknik Çizim / Technical Drawing

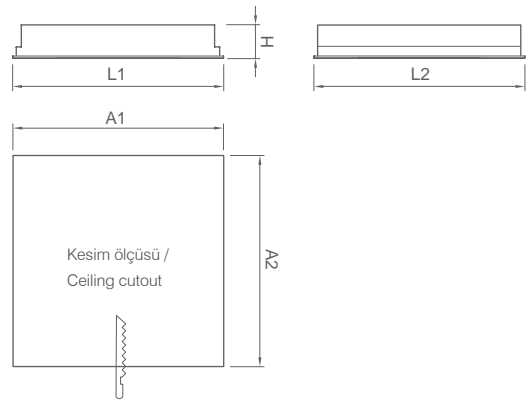

## Teknik Bilgi / Technical Data

Güç (W)	Çıkış / Output (lm)	Verimlilik (lm/W)	CRI (Ra)	Renk Sıcaklığı (K)	Ölçüler / Dimensions (mm)	Ağırlık (kg)	Ürün Kodu (Item Code)
					A1 A2 L1 L2 H		
42W	2600	62	>80	3000	575 575 595 595 95	6,5	161 0 660 3 242
42W	2720	64	>80	4000	575 575 595 595 95	6,5	161 0 660 4 242
54W	3200	59	>80	3000	575 575 595 595 95	6,5	161 0 660 3 131
54W	3360	62	>80	4000	575 575 595 595 95	6,5	161 0 660 4 131

## Ek Kod / Suffix Code

- (300) 3 saat Acil çıkış kiti / 3 hours Emergency gear
- (010) DALI

\* Tavan tipini belirtiniz. / Please indicate type of ceiling.

\*\* L demiri askı takımı, alçı tavanlar için / L brackets for plaster board ceilings

\*\*\* Lütfen daha fazla bilgi için satış temsilcileri ile görüşün. / Please contact for more information.

# BLOW

Clip-in (Metal) Tavan Armatürler / Clip-in Ceiling Luminaires



Polyester elektrostatik toz boyalı gövde /  
Electrostatic polyester powder coated

Yüksek geçirgenlikli satine PMMA veya PC opal difüzör /  
High diffusion and transmission satin opal PMMA or PC diffuser

Estetik aydınlatma / Aesthetics illumination

MacAdam 3 LED renk toleransı /  
Colour tolerance MacAdam 3

DALI, SwitchDIM ve Acil seçenekleri /  
DALI, SwitchDIM and Emergency options

## Özellikler / Specifications



## Renk Seçenekleri / Colour Options



Beyaz  
White

## Fotometrik Bilgi / Photometric Data

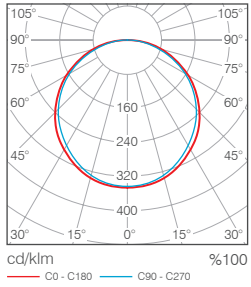

## Tavan Bilgi / Ceiling Data

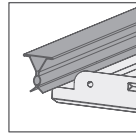

Clip-in tavan /  
Clip-in ceiling

## Teknik Çizim / Technical Drawing

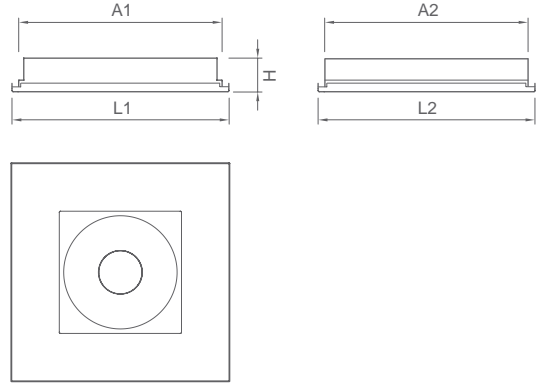

## Teknik Bilgi / Technical Data

Güç (W)	Çıkış / Output Lumen (lm)	Verimlilik (lm/W)	CRI (Ra)	Renk Sıcaklığı Colour Temp. (K)	Ölçüler / Dimensions (mm) A1 A2 L1 L2 H	Ağırlık Weight (kg)	Ürün Kodu Item Code
42W	2600	62	>80	3000	575 575 600 600 95	6,5	163 0 660 3 242
42W	2720	64	>80	4000	575 575 600 600 95	6,5	163 0 660 4 242
54W	3200	59	>80	3000	575 575 600 600 95	6,5	163 0 660 3 131
54W	3360	62	>80	4000	575 575 600 600 95	6,5	163 0 660 4 131

## Ek Kod / Suffix Code

- (300) 3 saat Acil çıkış kiti / 3 hours Emergency gear
- (010) DALI

\* Tavan tipini belirtiniz. / Please indicate type of ceiling.

\*\* Lütfen daha fazla bilgi için satış temsilcileri ile görüşün. / Please contact for more information.



# BLOW AR

Clip-in (Metal) Tavan Armatürler / Clip-in Ceiling Luminaires



Polyester elektrostatik toz boyalı gövde /  
Electrostatic polyester powder coated

Yüksek geçirgenlikli satine PMMA veya PC opal difüzör /  
High diffusion and transmission satin opal PMMA or PC diffuser

G53 AR111 LED spot seçeneği /  
G53 AR111 LED spotlight option

Estetik aydınlatma / Aesthetics illumination

MacAdam 3 LED renk toleransı /  
Colour tolerance MacAdam 3

DALI, SwitchDIM ve Acil seçenekleri /  
DALI, SwitchDIM and Emergency options

## Özellikler / Specifications



## Renk Seçenekleri / Colour Options



Beyaz  
White

## Fotometrik Bilgi / Photometric Data

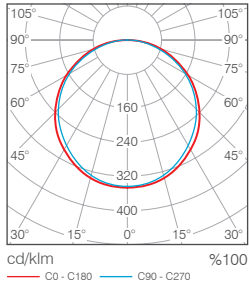

## Tavan Bilgi / Ceiling Data

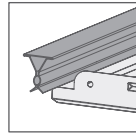

Clip-in tavan /  
Clip-in ceiling

## Teknik Çizim / Technical Drawing

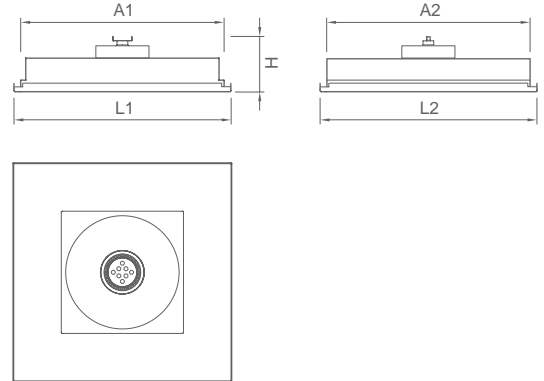

## Teknik Bilgi / Technical Data

Güç (W)	Çıkış / Output Lumen (lm)	Verimlilik (lm/W)	CRI (Ra)	Renk Sıcaklığı Colour Temp. (K)	Ölçüler / Dimensions (mm) A1 A2 L1 L2 H	Ağırlık Weight (kg)	Ürün Kodu Item Code
42W + 15W	2600+850	62	>80	3000	575 575 600 600 95	7,4	173 0 660 3 242
42W + 15W	2720+900	64	>80	4000	575 575 600 600 95	7,4	173 0 660 4 242
54W + 15W	3200+850	59	>80	3000	575 575 600 600 95	7,4	173 0 660 3 131
54W + 15W	3360+900	62	>80	4000	575 575 600 600 95	7,4	173 0 660 4 131

## Ek Kod / Suffix Code

- (300) 3 saat Acil çıkış kiti / 3 hours Emergency gear
- (010) DALI

\* Tavan tipini belirtiniz. / Please indicate type of ceiling.

\*\* Lütfen daha fazla bilgi için satış temsilcileri ile görüşün. / Please contact for more information.

VEKSAN  
LIGHTING





BLOW



**VEKSAN Aydınlatma San. ve Tic A.Ş.**  
**Lighting Industry & Trade Co. Inc.**

**Fabrika:** Eskişehir Organize Sanayi Bölgesi (EOSB)  
21.Cadde No:5, Eskişehir / TR  
T +90 (222) 236 8486 (pbx)  
F +90 (222) 236 8492

**Ofis:** Bahçeşehir 1. Kısım Mah. Sığırcık Sk.  
Badem 5 Villa:10 Başakşehir, İstanbul/ TR  
T +90 (212) 798 3333 (pbx)  
F +90 (212) 798 3338

**Showroom:** Meşrutiyet Cad. Evliya Çelebi Mah.  
Nur Ap. No:98 K:2 D:6 Beyoğlu, İstanbul / TR  
T +90 (212) 292 4481 (pbx)  
F +90 (212) 292 4476

[veksan@veksan.com](mailto:veksan@veksan.com)

[www.veksan.com](http://www.veksan.com)